





Schweizerische Eidgenossenschaft
Confédération suisse
Confederazione Svizzera
Confederaziun svizra

Cyber-Defence der Armee. Armee 5.0?

Schweizer Tag der Sicherer Digitalisierung,
Rotkreuz, 27. August 2019

Thomas Bögli, Chef Cyber-Defence



«CCYD360053vVZEMBAH2O!»



Agenda



Digitalisierung, Souveränität und Disruption



Der Cyber-Raum und Kriege



Akteure und Bedrohung



Cyber Bund, VBS und Armee



Cyber-Lehrgang



Wie weiter?



Gesellschaft



Schweizer Armee
Führungsunterstützungsbasis



Digitale Souveränität



832



951



531



898



1075

Daimler	45 Mia
Volkswagen	72 Mia
BMW	39 Mia
Tesla	41 Mia
	197 Mia

Stand 20.08.19



Disruption

Das weltgrösste Taxiunternehmen besitzt keine Taxis

Der weltgrösste Unterkunftsanbieter besitzt keine Immobilien

Die weltgrösste Telefongesellschaft besitzt kein Telefonnetz

Der weltgrösste Medieninhaber produziert keine Inhalte

Der weltgrösste Filminhaber besitzt keine Kinos

Die weltgrössten Softwarehändler schreiben keine/wenig Apps

Die weltgrösste Personalrekrutierungs-Agentur besitzt keine Büros



UBER



NETFLIX





Agenda



Digitalisierung, Souveränität und Disruption



Der Cyber-Raum und Kriege



Akteure und Bedrohung



Cyber Bund, VBS und Armee



Cyber-Lehrgang



Wie weiter?



Der Cyber-Raum



«Akteure» (Rollen)



Soziale Interaktionen



«Interfaces»

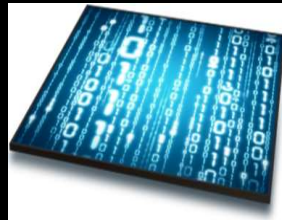
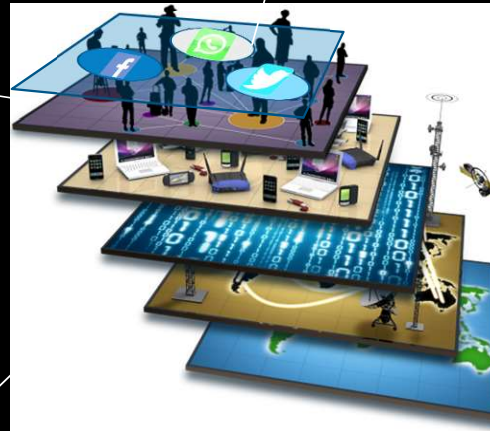

«Logische Netzwerke»



«Reale geografische Welt»

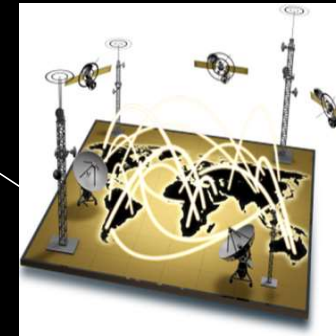

«Physische Netzwerke»



Kriege



- 1.0 Linien- und Kolonnenformation
- 2.0 Artillerie erobert, Infanterie besetzt
- 3.0 Blitzkrieg
- 4.0 Atomwaffen
- 5.0 Cyber in war



Moderne Kriege



- uneingeschränkte Kriegsführung in allen Operations-Räumen
- dezentralisierter Ansatz
- keine definierbaren Fronten
- staatliche und nichtstaatliche Akteure
- unbemannt und unerkannt
- autonome Waffen mit AI





Operations-Sphären der Armee



- Bodenraum
- Luftraum
- Elektromagnetischer Raum
- Informationsraum
- Cyber-Raum



Agenda



Digitalisierung, Souveränität und Disruption



Der Cyber-Raum und Kriege



Akteure und Bedrohung



Cyber Bund, VBS und Armee



Cyber-Lehrgang



Wie weiter?



Spending for Cyber-"War"



	Country	Mio \$ / Y	Personnel
	USA	7.000	9.000
	China	1.500	20.000
	Russia	300	1.000
	Israel	150	1.000
	Great Britain	450	2.000
	France	220	800
	Germany	250	1.000
	South Korea	400	700
	North Korea	200	4.000

(by 2016)



Kommando Cyber- und Informationsraum

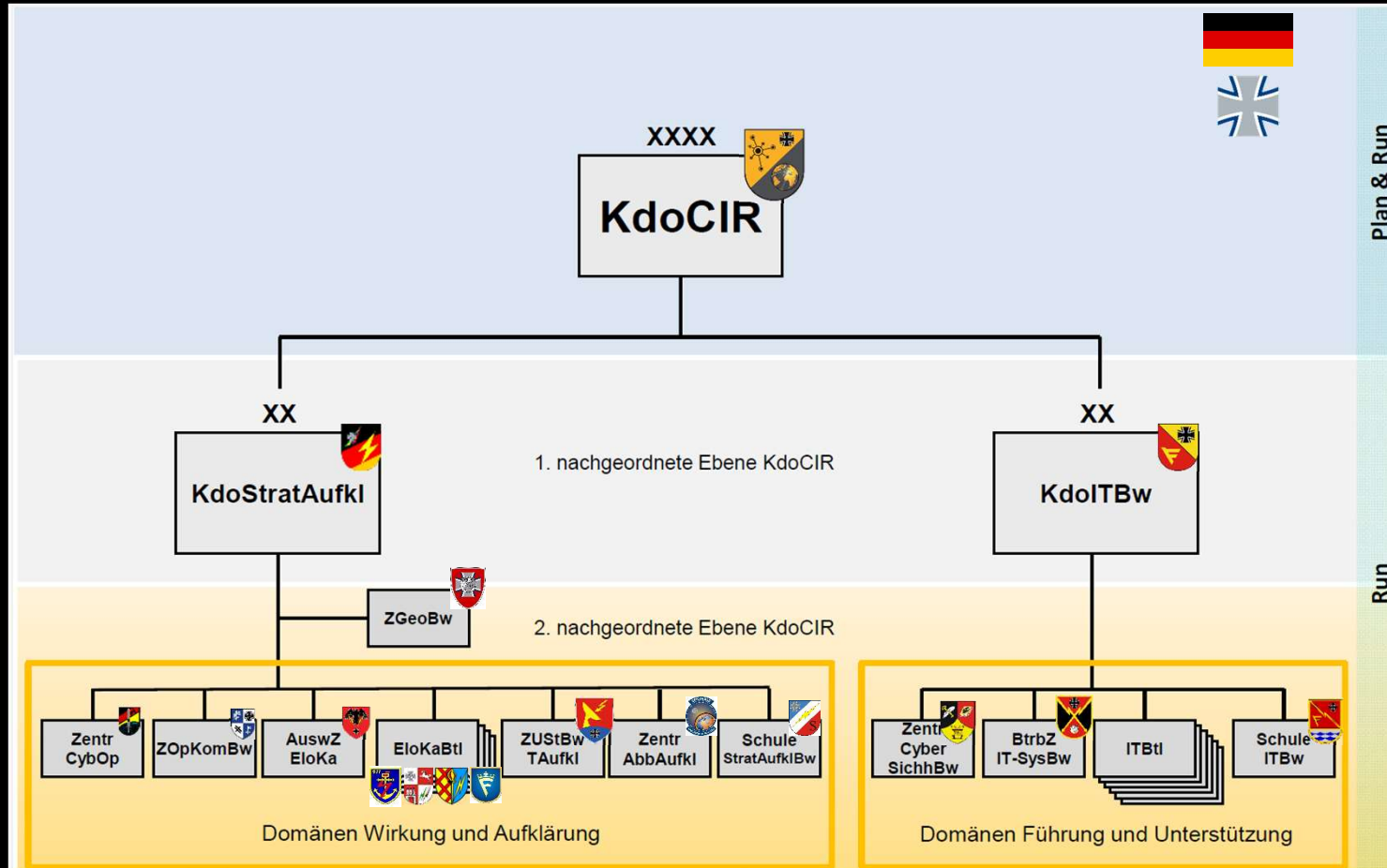



China



- Bis 2030 150 Mia US\$ Investitionen in die Entwicklung von Artificial Intelligence
- Etablierung einer Cyber-"Miliz" mit mehr als 10 Mio Mitgliedern
- Integrierung "nationalistischer Hacker"
- Universitäten und Hochschulen bilden potentielle zukünftige Cyber-Akteure aus.



Risiken und Gefahren

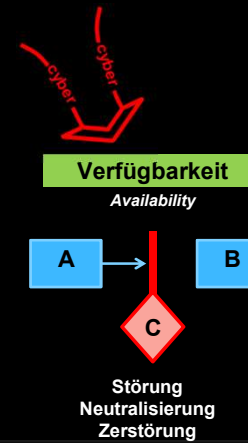
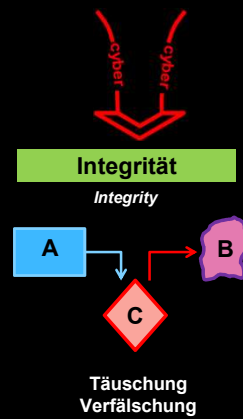
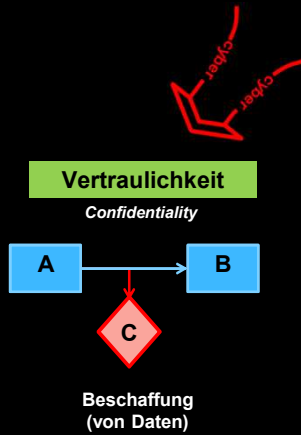
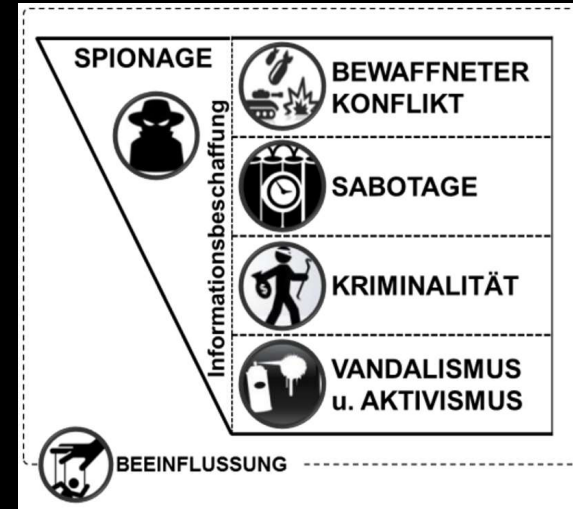
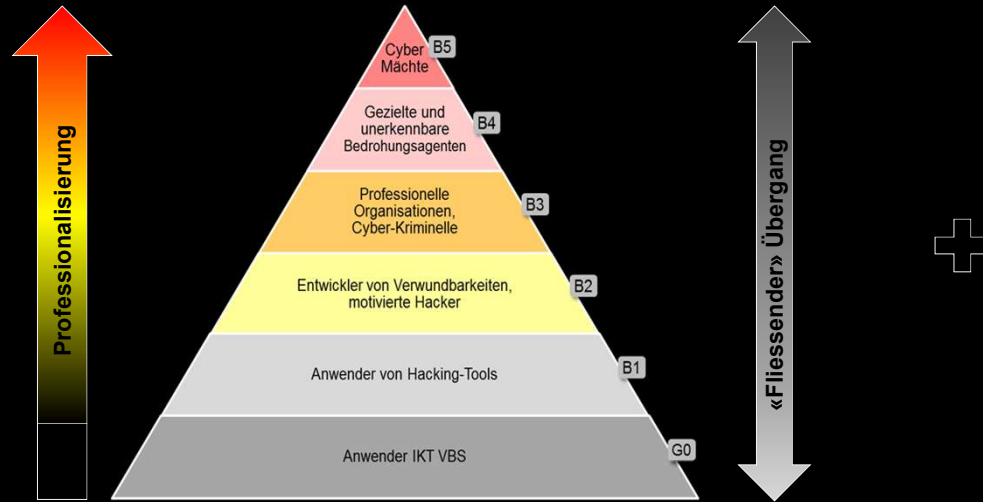

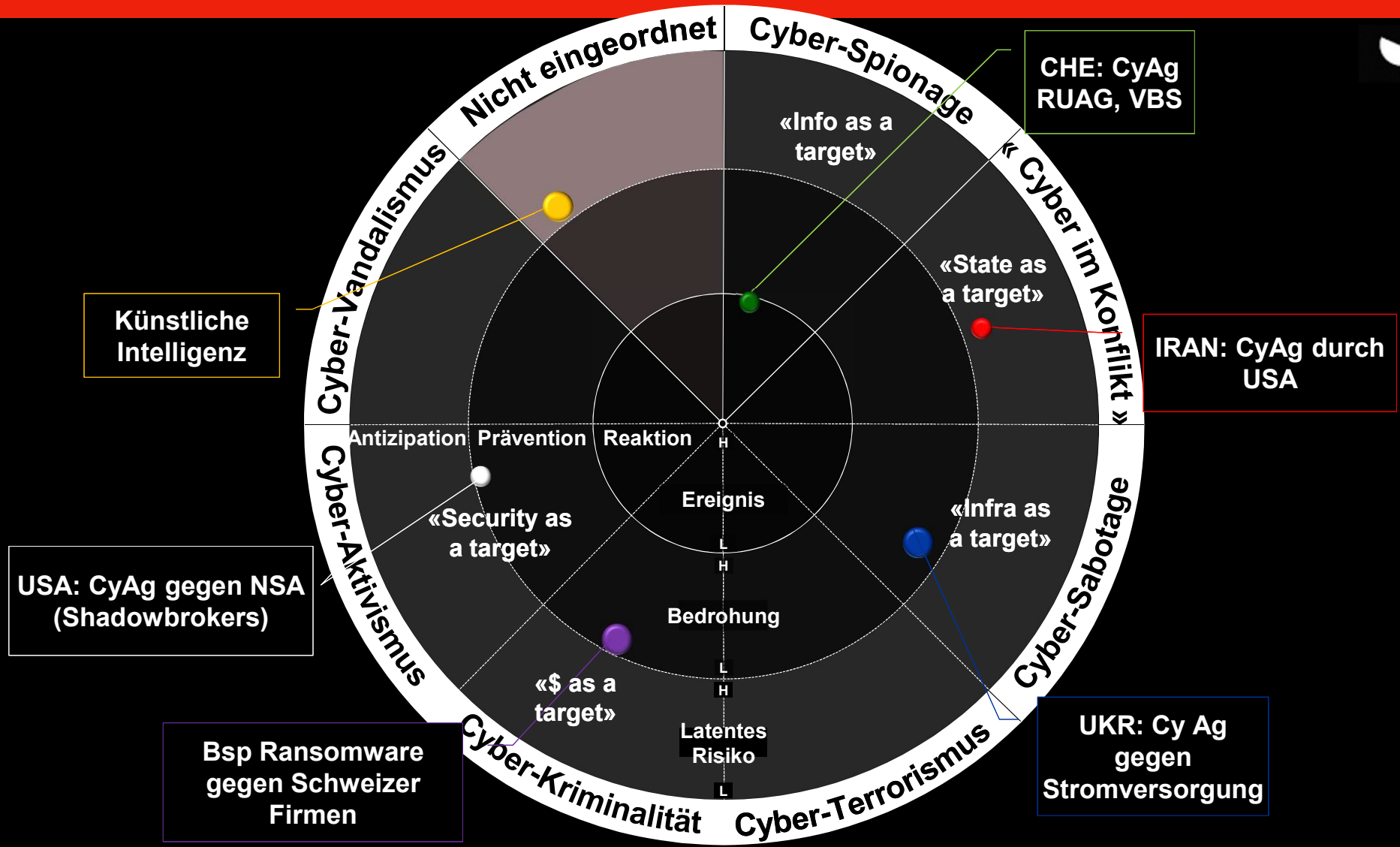



Beispiel "Flirt App der Hamas"

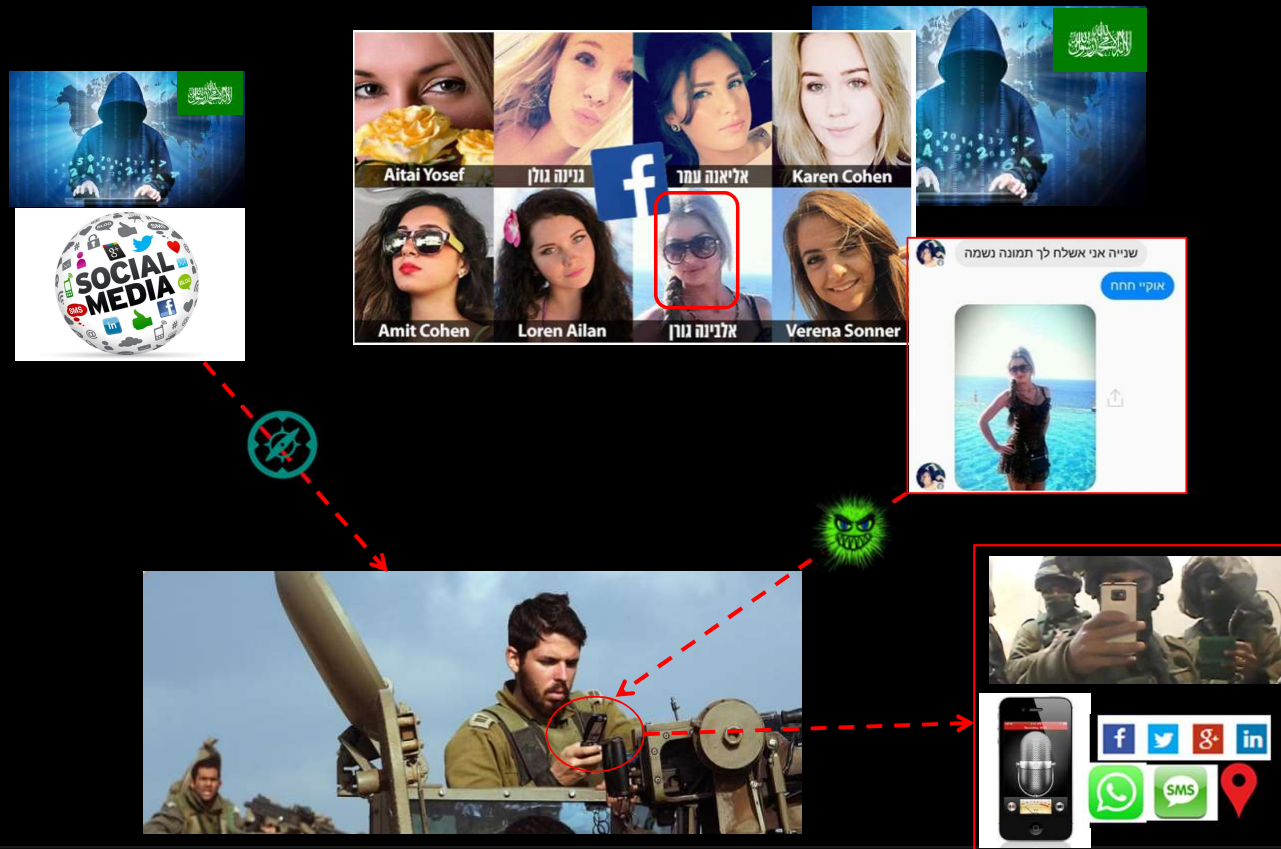



Mögliche nächste Schritte

Je nach Absicht und Ressourcen des Angreifers



Der «Brückenkopf» für weiterfolgende Operationen



Kamera aktivieren, gespeicherte Bilder auslesen



Mikrofon aktivieren, Gespräche aufzeichnen



Geolokalisierung

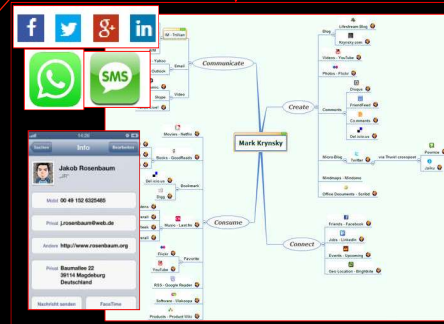

Daten auslesen, Beziehungsnetze «kartographieren»

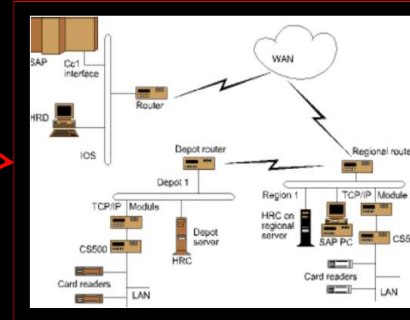

Netzwerke «kartographieren» und Einfluss nehmen

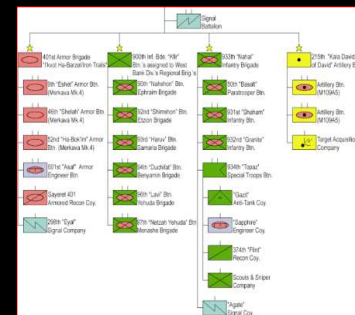

Personen den Organigrammen zuordnen, Truppen lokalisieren / Bewegungen erfassen



Agenda



Digitalisierung, Souveränität und Disruption



Der Cyber-Raum und Kriege



Akteure und Bedrohung



Cyber Bund, VBS und Armee



Cyber-Lehrgang



Wie weiter?



Politischer Vorstoss



Motion Eder (17.3508)

- **Schaffung eines Cyber-Security-Kompetenzzentrums auf Stufe Bund**

Chronologie

- 19.09.2017 Ständerat: Annahme
- 07.12.2017 Nationalrat: Annahme

<https://www.parlament.ch/de/ratsbetrieb/suche-curia-vista/geschaeft?AffairId=20173508>



Cyber-Security Kompetenzzentrum Bund

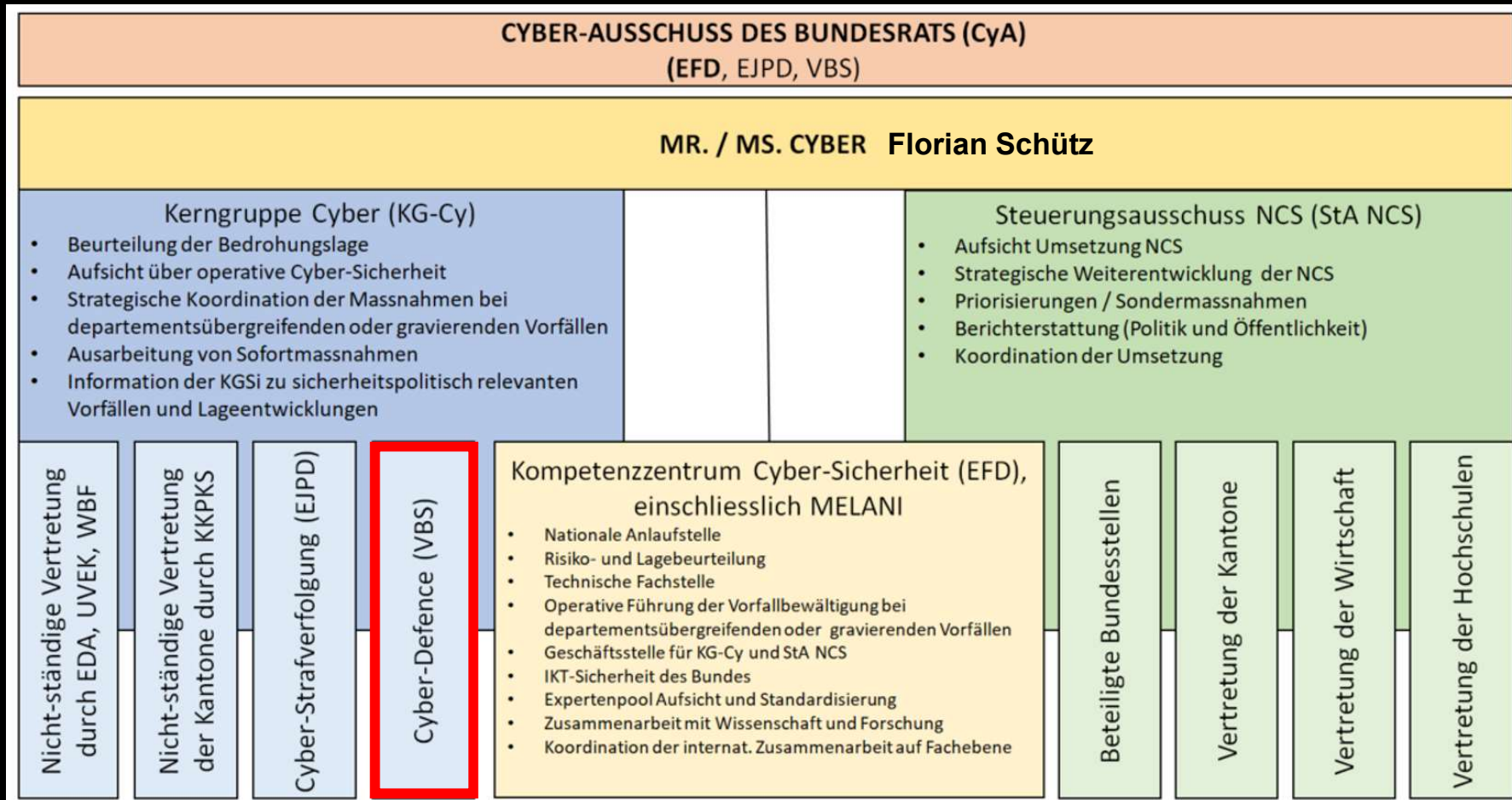



Cyber im VBS

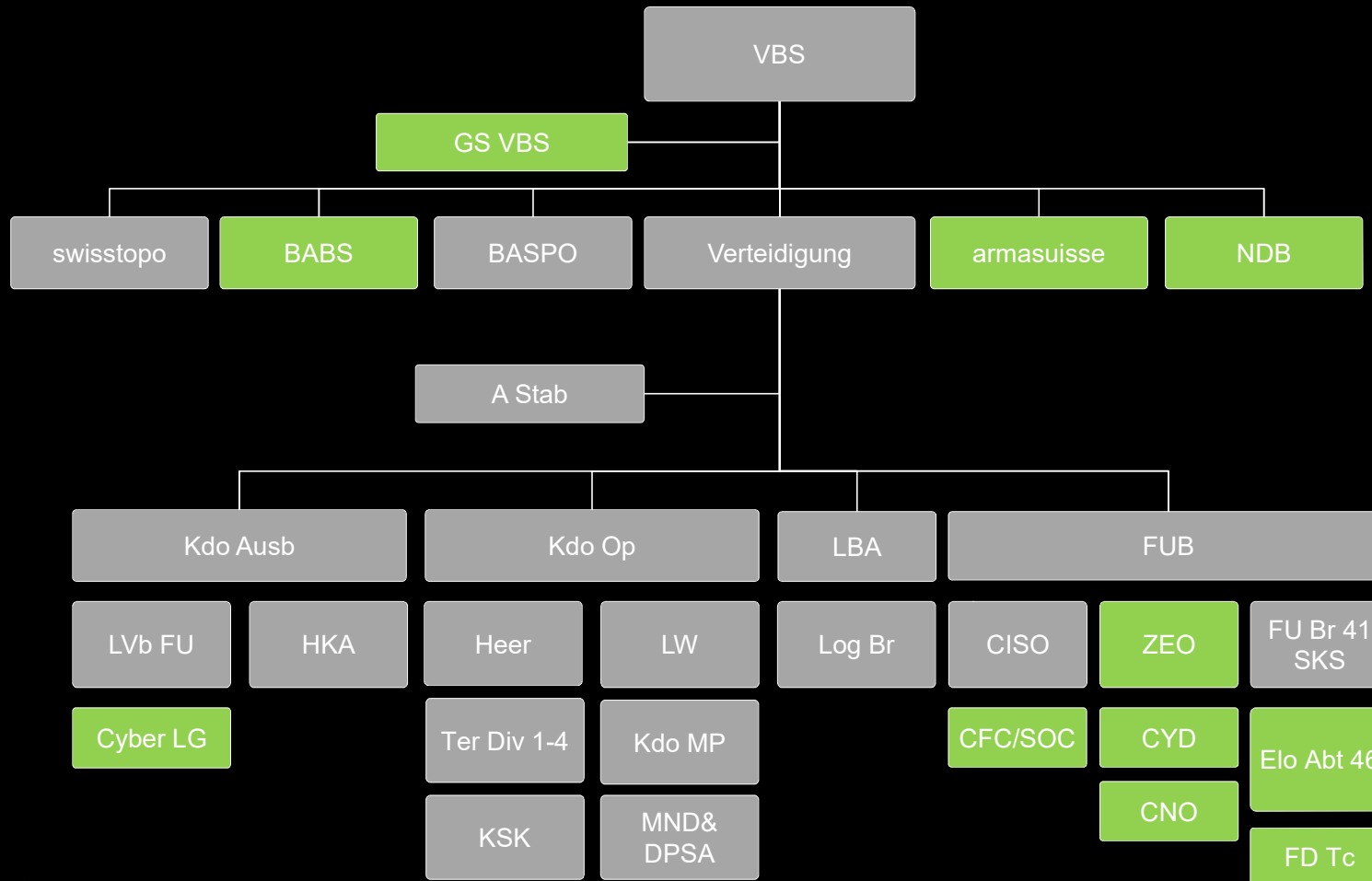



Positionierung der Armee im nationalen Dispositiv

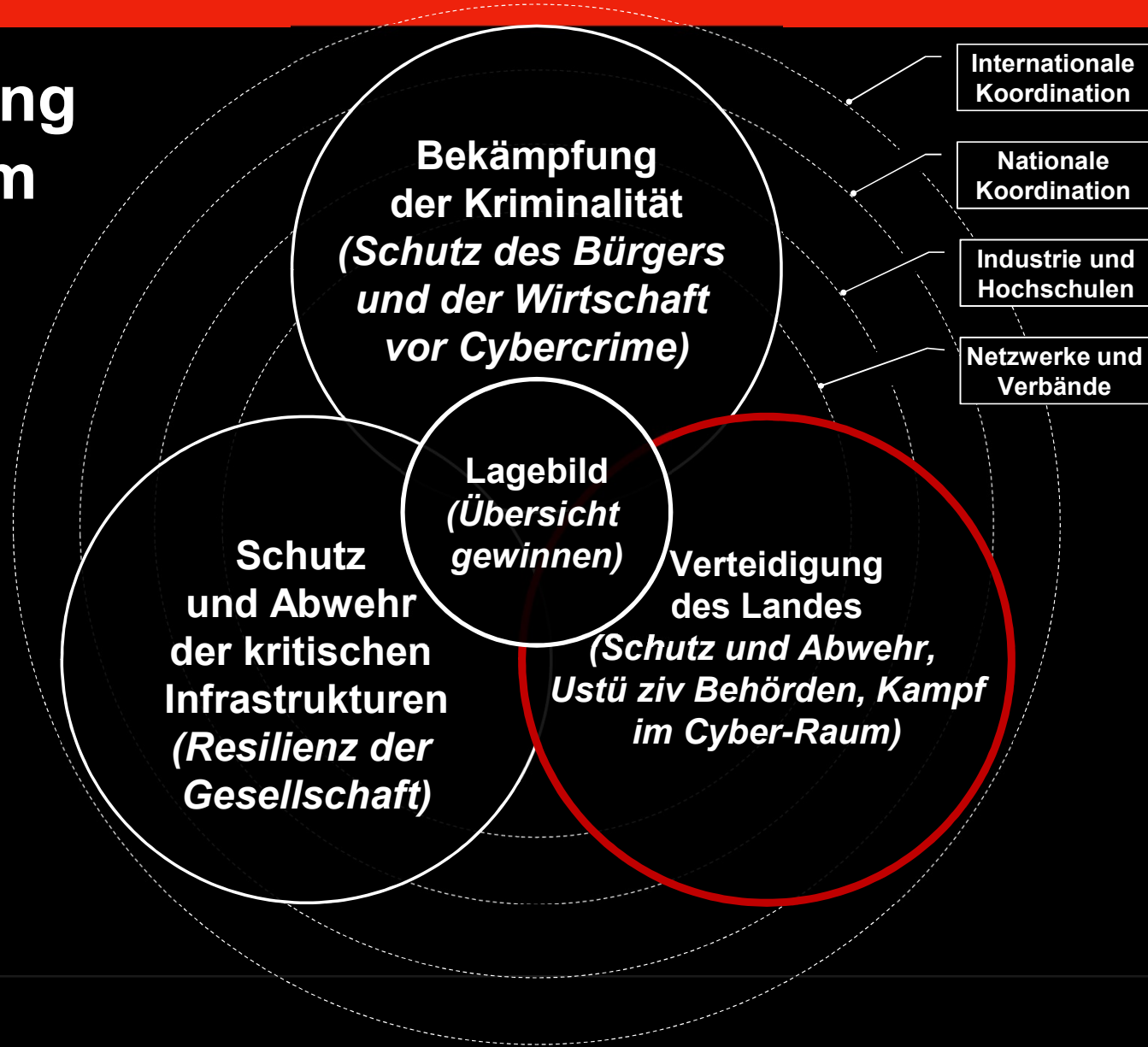



Vorgehen der Schweizer Armee



Programm FITANIA



Rechenzentren
VBS/Bund 2020

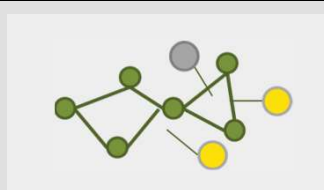

Führungsnetz
Schweiz



Telekommunikation
der Armee

Aufbau Cyber in der Armee

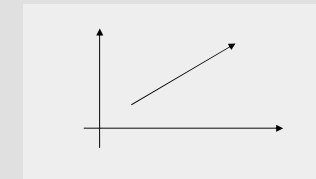

Bestehende
Fähigkeiten weiter
ausbauen



Ausbau der
Berufsorganisation
mit Spezialisten

Plan d'Action Cyber Défense (PACD)



Erhöhung des
Bestandes der
Miliz
Soldaten und
Kader



Cyber-Fähigkeiten



passiv / defensiv

aktiv / offensiv

Antizipation

Prävention

Reaktion

Wirkung

Cyber Lagebild

Schutz
im Cyberraum

Abwehr im
Cyber Rm

Aktionen im
Cyber Rm



permanent situativ



Die Organisation der FUB

Das "Cyber-Kommando"

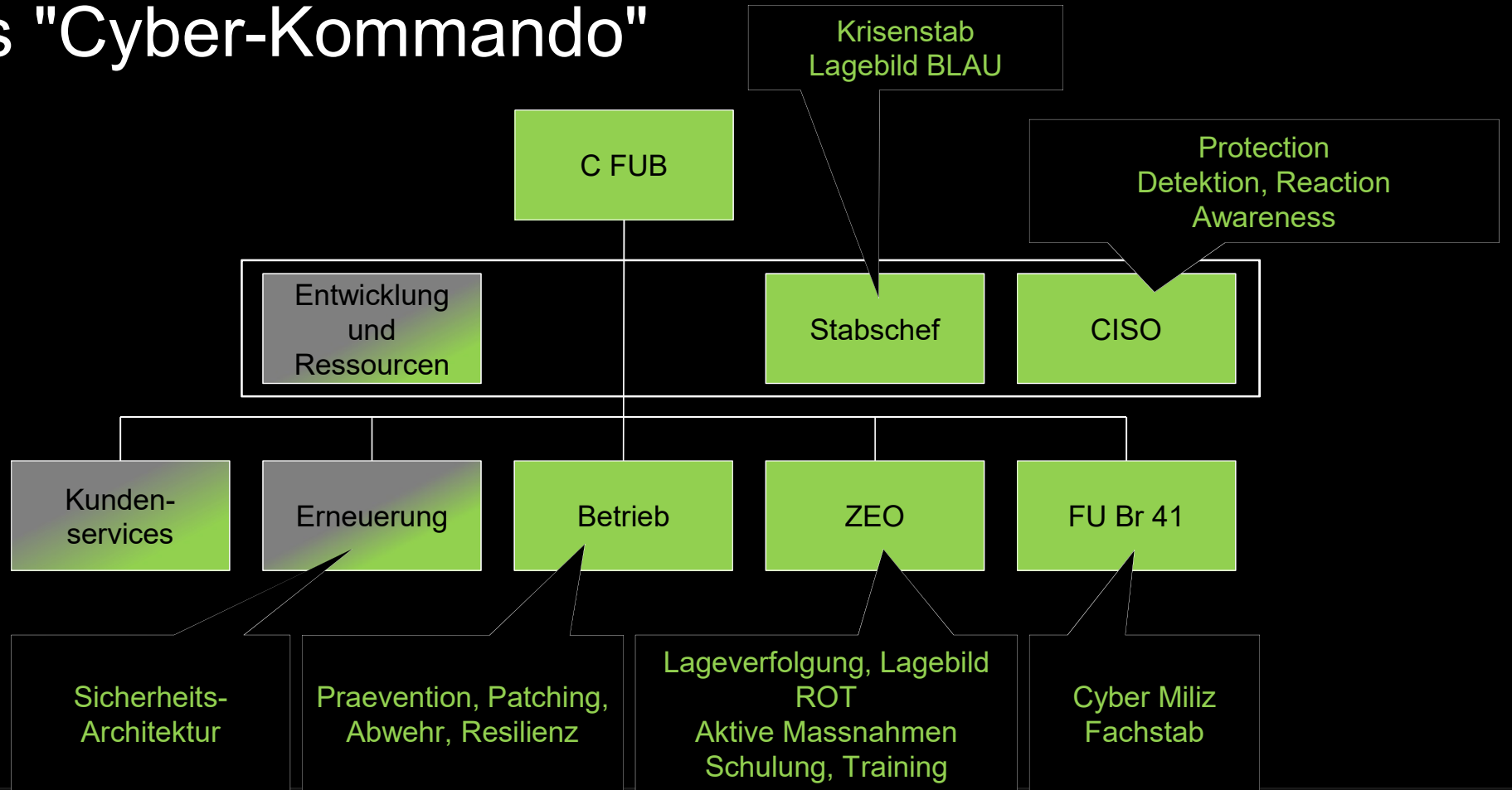



Agenda



Digitalisierung, Souveränität und Disruption



Der Cyber-Raum und Kriege



Akteure und Bedrohung



Cyber Bund, VBS und Armee



Cyber-Lehrgang



Wie weiter?



Politischer Vorstoss



Motion Dittli (17.3507)

- **Ein Cyber-Defence Kommando mit Cybertruppen für die Schweizer Armee**

Chronologie

- 25.09.2017 Ständerat: Annahme
- 13.12.2017 Nationalrat: Annahme mit einzelnen Änderungen

<https://www.parlament.ch/de/ratsbetrieb/suche-curia-vista/geschaeft?AffairId=20173507>



Cyber-Lehrgang



- Durchführung an der Elektronischen Kriegführungsschule 64 (EKF S 64) in Jassbach
- Dauer 40 Wochen
- Bereitschaft Wachtmeister zu werden

Cyber-Lehrgang (40 Wochen)				
EKF RS 64-2/18			EKF UOS	EKF RS 64-1/19
AGA *	FGA	VBA	UOS	Praktischer Dienst als Wachtmeister
6 Wochen	7 Wochen	5 Wochen	4 Wochen	18 Wochen
Folgender Lehrgang				
AGA *	FGA	VBA	UOS	Praktischer Dienst als Wachtmeister
6 Wochen	7 Wochen	5 Wochen	4 Wochen	18 Wochen



Cyber-Lehrgang



Bloss nicht auffallen! – Die ersten Cyber-Rekruten haben ihre Ausbildung begonnen

Die Armee hat diesen Sommer begonnen, die ersten Milizleute im Bereich Cyber Defence auszubilden – in Zusammenarbeit mit der Wirtschaft. Die Bilanz ist positiv, doch der reguläre Betrieb beginnt erst.

Lukas Mäder, Bern
21.9.2018, 16:30 Uhr



Tätigkeit in einem sensitiven Bereich: ein Teilnehmer des ersten Cyber-Lehrgangs der Armee in der Kaserne Jassbach. (Bild: Peter Schneider / Keystone)

Nach dem Theoriebüffeln freut sich Cyber-Rekrut Roger auf den Praxisteil



abzuwehren.

Armee-Chef über die ersten Cyber-Krieger

BLICK in der Nerd-RS

Sie müssen 40 Wochen investieren und ihre RS im hintersten Berner Chrachen absolvieren. Doch die ersten Cyberpioniere der Armee sind begeistert vom neuen Lehrgang: Im Dienst des

Neuer Lehrgang

21. September 2018 15:45; Akt: 21.09.2018 15:45

Erster Cyber-Lehrgang für Rekruten angelaufen

Die Schweizer Armee bildet erstmals Rekruten zu Cyber-Spezialisten aus. Damit haben die jungen Männer auch im Zivilleben etwas in der Hand.



Ausbildungsbereiche



Spezialist Computer Network Operations (CNO)

- Entwickler von Softwarewerkzeugen
- Analyst von Cyber-Ereignissen und Attacken
- Analyst von Schwachstellen

Spezialist military Computer Emergency Response Team (milCERT)

- Analysen von Cyber-Bedrohungen auf die Informatik- und Kommunikationstechnik Systeme der Armee
- Incidentmanagement
- Technische und forensische Untersuchungen

Spezialist Cyber Defence (CYD)

- Lage-Analyse und -Darstellung
- Unterstützung (auch technisch/forensisch), Beratung und Ausbildung von Truppen im Feld
- Aufklärung verbotener ND

- Anerkennung der Ausbildung:
Berufsprüfung zum "Cyber Security Specialist" mit eidgenössischem Fachausweis

Cyber Training und Übungen



- SVU19 / TERROR19 / CP19 11. - 13. Nov 2019
- CYBER-COALITION 19 02. - 06. Dez 2019
- LOCKED-SHIELDS 20 26. - 30. April 2020





Herausforderungen 2020ff



- protect, **detect**, respond
- üben, üben, üben
- Aufbau Cyber Training Center **CTC**
- SOC as a Service **SaaS**
- **Praktikum** Cyber-Lehrgang
- Cyber-Kommando



Politischer Vorstoss



Interpellation Candinas (19.3866)

- Ein Cyberkommando für die Schweizer Armee

Chronologie

- im Rat noch nicht behandelt

19.3866	INTERPELLATION
Ein Cyberkommando für die Schweizer Armee?	
Eingereicht von:	 CANDINAS MARTIN CVP-Fraktion Christlichdemokratische Volkspartei der Schweiz
Einreichungsdatum:	21.06.2019
Eingereicht im:	Nationalrat
Stand der Beratungen:	Im Rat noch nicht behandelt



Armee vs Sackmesser



Cyber-Raum



Herzlichen Dank für Ihre Aufmerksamkeit!

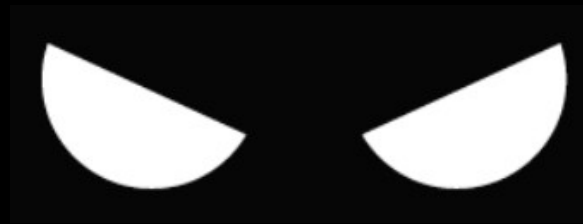

www.cyberdefence.ch

Schweizer Armee
Führungsunterstützungsbasis